

# IS25T

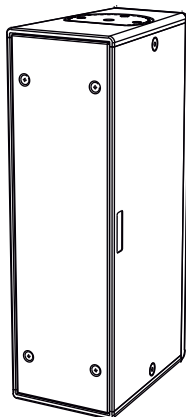

## QUICK START USER MANUAL

### Section 1

The warnings in this manual must be observed together with the "USER MANUAL - Section 2".

Le avvertenze nel presente manuale devono essere osservate congiuntamente al "MANUALE D'USO - Sezione 2".

Die Warnungen in diesem Handbuch müssen in Verbindung mit der "BEDIENUNGSANLEITUNG - Abschnitt 2" beobachtet werden".

Les avertissements spécifiés dans ce manuel doivent être respectés ainsi que les "CARACTERISTIQUES TECHNIQUES -Section 2"

Las advertencias del presente manual se deben tener en cuenta conjuntamente con las del "MANUAL DEL USUARIO" - Sección 2".

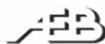

A.E.B. Industriale Srl Via Brodolini, 8 Località Crespellano 40053 VALSAMOGGIA BOLOGNA (ITALIA)  
Tel +39 051 969870 Fax +39 051 969725 [www.dbtechnologies.com](http://www.dbtechnologies.com) [info@dbtechnologies-aeb.com](mailto:info@dbtechnologies-aeb.com)



**EXAMPLES OF INSTALLATION WITH OPTIONAL ACCESSORIES**

SEE THE COMPLETE MANUAL FOR FURTHER DETAILS AND FOR THE COMPLETE LIST OF THE ACCESSORIES. THE PICTURES ARE FOR INFORMATION ONLY.

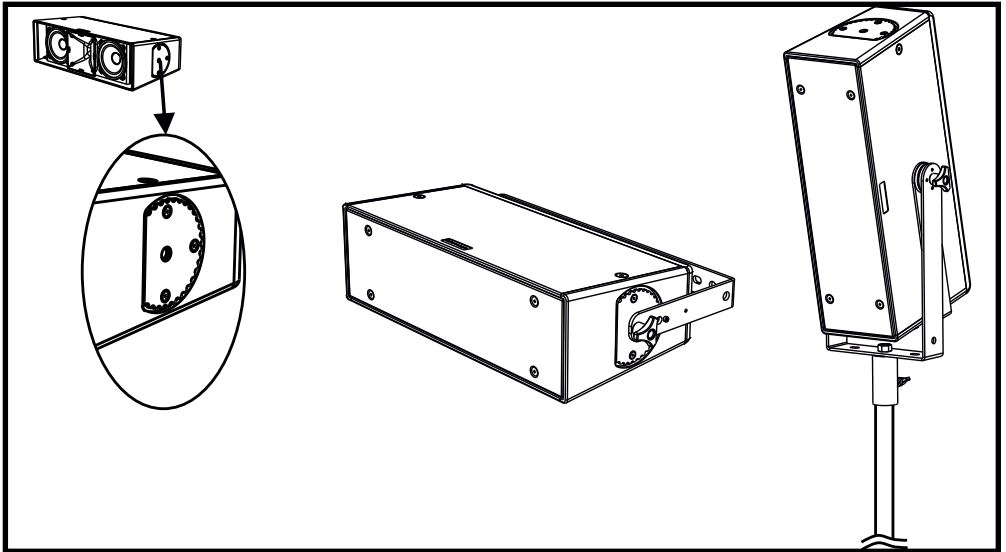

**REAR CONNECTORS  
(EXAMPLE)**

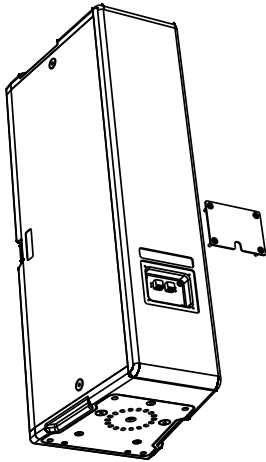

(ALL PICTURES SHOWN IN THIS BOX  
ARE FOR ILLUSTRATION PURPOSE ONLY)  
THE ADDITIONAL CONNECTORS, CABLES  
AND EQUIPMENT ARE NOT SUPPLIED

**INPUT**

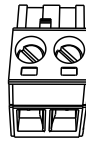
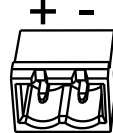

**AMPLIFIER**

**LINK**

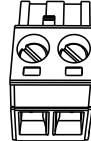
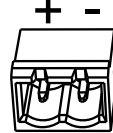

**LINKED  
SPEAKER**

## MAIN FEATURES

Type:	2-ways passive speaker, wooden box, water paint coating
Connector type:	Euroblock (Phoenix)
Main installation uses:	Wall mounted/horizontal/vertical
Main accessories:	Optional brackets
Rigging points:	Integrated mechanics

## ACOUSTIC SECTION

HF exit:	1"
HF voice coil:	1.4"
LF transducer:	2x 5"
LF voice coil:	1"
Sensitivity:	94.5 dB
Frequency response (-6 dB):	85 Hz -20 kHz (dBTechnologies preset)
Max SPL (calculated):	121.5 dB (peak power)
Dispersion (H x V):	100° x 60°
Xover frequency:	1.5 kHz (internal Xover)

## POWER SECTION

Nominal Impedance:	8 Ω
Power Handling (RMS):	120 W
Power Handling (Peak):	480 W

## DIMENSIONS AND WEIGHT

Width:	152 mm   6 in
Height:	485 mm   19 in
Depth:	240 mm   9.4 in
Weight:	7 kg   15.4 lbs

Check the updated version of this document on: [www.dbtechnologies.com](http://www.dbtechnologies.com), where you can find also all the suggestions about EQ for the best use of this speaker.



**CAUTION:** For installation and the usage of the accessories is mandatory to refer to the complete user manual, available on: [www.dbtechnologies.com](http://www.dbtechnologies.com), any other usage is prohibited.



Scan with your QR Reader App to download the complete User Manual!

Features, specification and appearance of products are subject to change without notice. dBTechnologies reserves the right to make changes or improvements in design or manufacturing without assuming any obligation change or improve products previously manufactured.