



Spec Sheet

DVX D12 HP

2-Way Active Speaker
12"/1.4", 700W **Digipro G2**



Applications

- Compact live sound reinforcement system
- Foreground / background music, infill / delay
- Portable PA, retail, clubs, ballrooms, houses of worship, corporate AV, live theatres
- Stage monitoring

Features

- 2-Way Active Speaker
- 60° x 40° rotatable aluminium CD horn
- 12" woofer; 1.4" compression driver
- 700W RMS Class-D Digipro® G2 amplifier
- Dual angle enclosure for both front-of-house and floor monitor applications
- 24 bit/48 kHz DSP processing with 2 presets for full-range or stage monitor use
- RMS/Peak, Thermal, Multiband Limiter

Description

The DVX HP series combines an impressive set of features that makes these speakers the ideal solutions for a wide range of applications.

New Digipro® G2 power amp technology and state-of-the-art transducers put them far beyond the standards in their class in terms of sound pressure, performance and response.

The high quality input boards, the high-resolution digital sound processing and the rotatable HF horns joined to the multifunctional birch multiplex cabinets equipped with rigging points, rails, and other flexible configuration options, grant to the DVX HP series an unrivalled price-to-performance ratio that will surprise even the most demanding professionals.

The DVX D12 HP bi-amped active speaker is equipped with a 700W RMS Digipro® G2 module with Switched Mode Power Supply. This highly efficient power amplifier provides high power with limited weight and dimension. Thanks to the low power dissipated, the cooling of the amplifier module does not require a fan.

The integrated DSP carries out various tasks, such as controlling the power amp, serving as an active equalizer, x-over and high-pass filter. It also performs audio setup tasks, such as aligning phases and delay time, and controlling the limiter to ensure utmost reliability and operating safety. A switch enables to select one of the two different equalizations - "FLAT" or "STAGE MONITOR" - to provide high versatility for different applications.

The LF transducer is a 12" woofer with a 3" voice coil. The HF transducer is a 1.4" compression driver with 3" voice coil on a 60° x 40° CD-horn. This specially designed rotatable high-frequency horn provides a very clean and constant directivity. All high-frequency horns are made of aluminium to help keep their drivers cool.

The speaker has been designed to be used also as stage monitor (45° angle). By rotating the horn you can maintain the same coverage angle when the speaker is used as monitor. The horizontal directivity is 60° by default factory setting.

The speaker is made of 15mm birch plywood. The three handles (one on top; one on each side), the 6 fly-tracks, the 6 M10 threads and the 4 fly-pins located on the sides of the speaker are enabling easy transport and installation. The standard aluminium pole mount cup (Ø36mm) in the bottom of the box lets you to use this speaker also on a subwoofer or a speaker stand.

DVX D12 HP

Technical Specifications

System Specifications

Speaker Type	2-Way Active Speaker
--------------	----------------------

Acoustical Data

Frequency Response	[- 10dB] [- 3dB]	55 - 20.000 Hz 68 - 19.000 Hz
Max SPL		131 dB
HF Voice Coil HF		1.4" 3"
Directivity		60° x 40°
Horn		CD Horn Aluminium
Rotatable Horn		YES
LF Voice Coil LF		12" 3"

Amplifier

Amp Technology	Digipro® G2
Amp Class	Class D
Power RMS Peak Power	700 W 1400 W

Processor

Controller	DSP 24 Bit/48 kHz	
System Presets	Flat, Monitor	
Limiter	RMS, Peak, Thermal, Multiband	
Crossover Frequency	LF-HF	1350 Hz

Mechanics

Housing	Multiplex birch plywood
Housing Design	Multifunctional
Angles Up	Monitor use 45°
Rigging Points	6 x M10, 4 x 10mm Quick Release for DTF-bracket
Flytracks	3 x on top; 3 x on bottom
Dimension (WxHxD)	370 x 625 x 395 mm 14.57 x 24.61 x 15.55 in
Weight	27.5 kg 60.63 lbs.

DVX D12 HP

Technical Specifications

Rear Panel

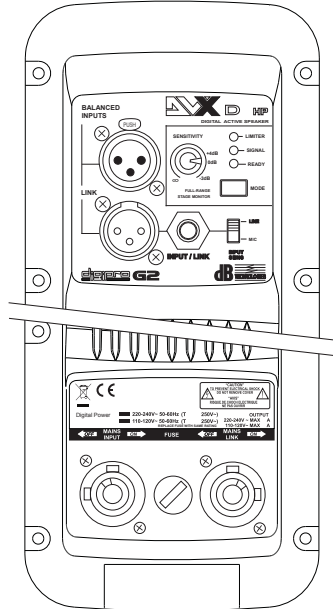

Overall Dimensions

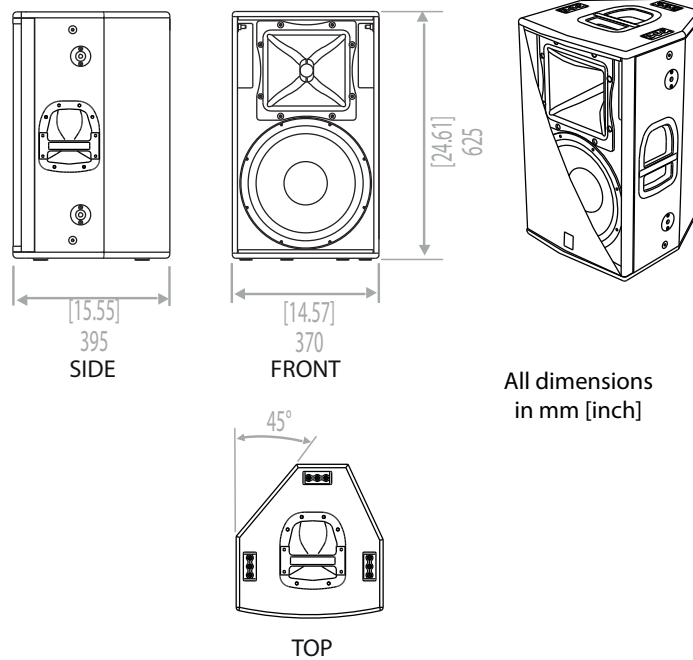

Accessories

DTF 12	Easy mount bracket for DVX D10HP
TC 12	Padded cover for DVX D12HP
TE M10	Eye-bolt set (4 pcs) with M10-thread
WB 09	Universal wall mount bracket, swivel and tilt Ø35mm pole mount

info@dbtechnologies.com www.dbtechnologies.com

dBTechnologies products are continually improved. All specifications are therefore subject to change without notice.